

Technické parametre

 Hydraulický žeriav Ostroj WM130NT	
Max. klopný moment	88 k.Nm
Max. vodorovný dosah	7000 mm
Nosnosť	7,0/1230 5,65/1550 m/kg
Uhol otoče	380 °
Krútiaci moment otoče	15 k.Nm
Obsah olejovej nádrže	160 l
Pracovný tlak	21 MPa
Max. prietok oleja	2x55 l/min
Hmotnosť	1530 kg

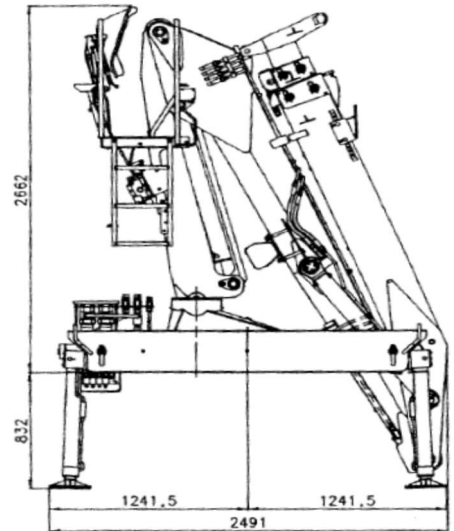

ROZMERY

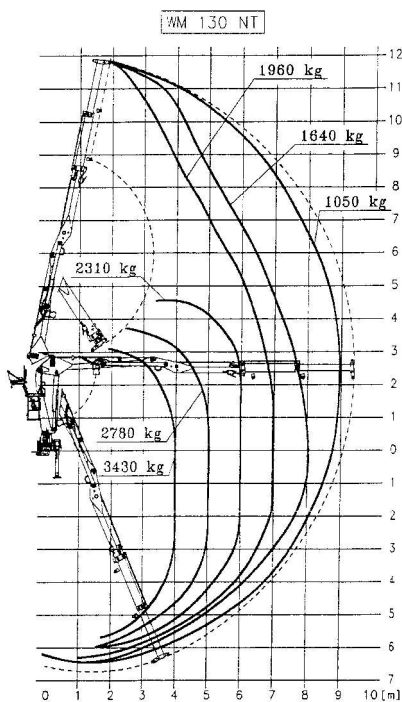

ZÁŤAŽOVÝ DIAGRAM

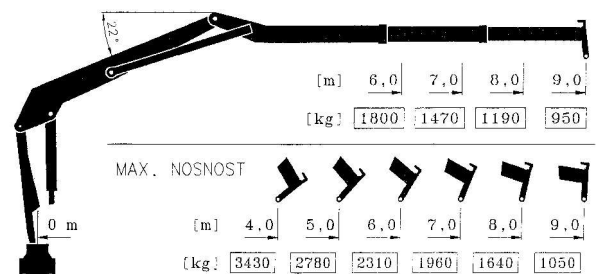
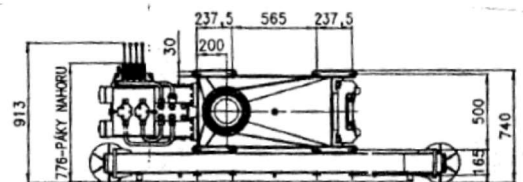

TABUĽKA NOSNOSTI