

Technische Angaben

 Hydraulische Kräne Ostroj WM130NT			
Max. Kippmoment	88	k.Nm	
Max. Waagrechte Reichweite	7000	mm	
Tragkraft	7,0/1230	5,65/1550	m/kg
Schwenkwinkel	380	°	
Drehmoment beim Schwenken	15	k.Nm	
Ölbehälterinhalt	160	l	
Arbeitsdruck	21	MPa	
Max. Öldurchfluss	2x55	l/min	
Gewicht	1530	kg	

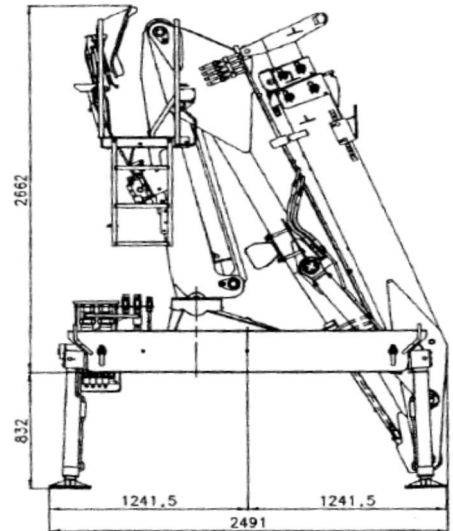

GRÖSSEN

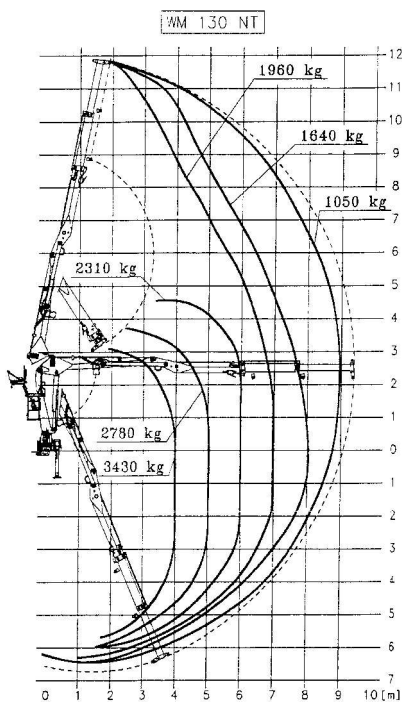
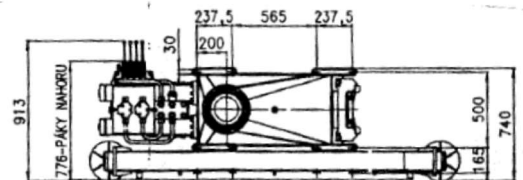

STROMBELASTUNGSPLAN

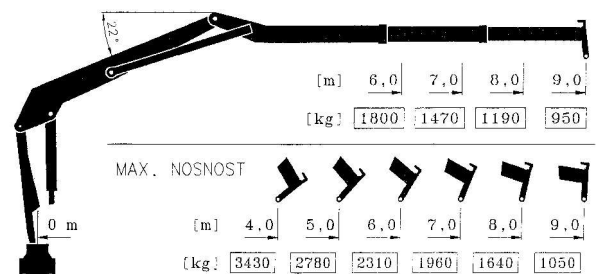

TRAGKRAFTTABELLE